

# OUTDOOR

2CM

PORCELAIN PAVERS



**MI****E**® *stone*  
Sustainable Tile, Made in the USA

# OUTDOOR

## PORCELAIN PAVERS

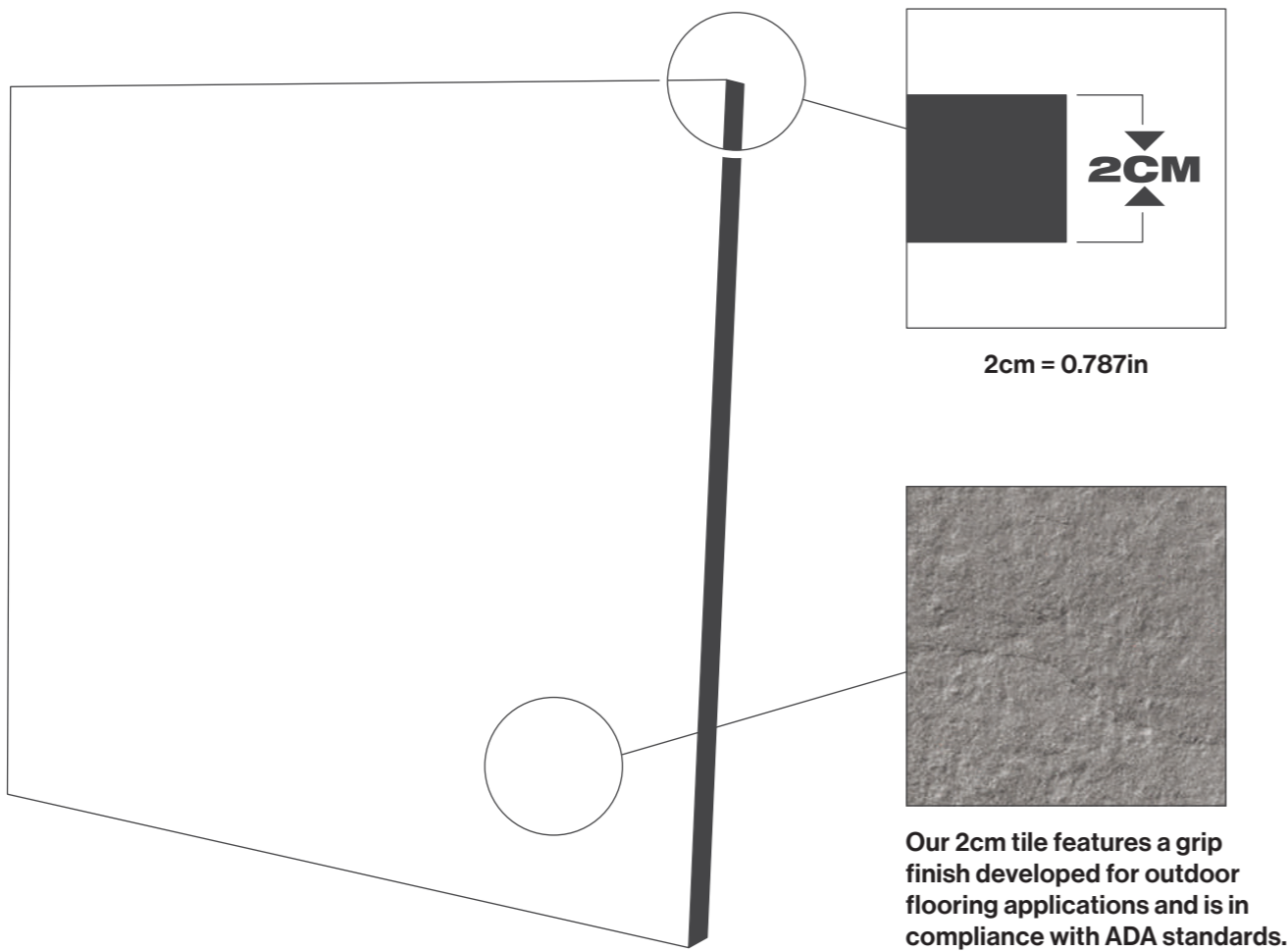

▼ **MOOD WOOD** | HONEY 12" x 48"



**BENEFITS** pg. 2

**+ONE** pg. 7



**AREA 51** pg. 11



**EARTH** pg. 15



**FARMHOUSE LIVING** pg. 23



**imprint** pg. 27



**LITH** pg. 31

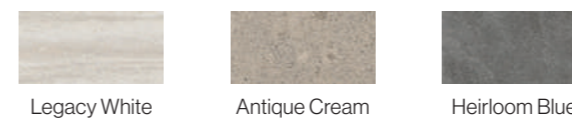

**MOOD WOOD** pg. 35

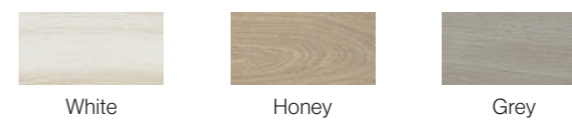

**QUARTZ** pg. 39



**SPECIFICATIONS** pg. 44

**INSTALLATION METHODS** pg. 46

# BENEFITS

OF MILE<sup>®</sup>stone OUTDOOR 2CM PORCELAIN PAVERS



## Resistant to Thermal Shock

Won't break due to gradual or sudden temperature changes (-40°F — 210°F).



## Made from Natural Raw Materials

Sourced locally within 500mi of our production facility, lowering our carbon footprint.



## Unmatched Durability

Stronger and more resilient than any alternative paving solution.



## Frost Resistant

Unaffected by frost or freezing since our pavers don't absorb water.



## V.O.C. Free

Emits 0 VOCs to protect occupants and environmental health.



## Cost-Over-Life Savings

With a 60+ year life expectancy, our pavers provide a low life cycle cost analysis.



## Resists Microbial Growth and Damage

Unaffected by moss, mold, and verdigris.



## Scratch and Stain Resistant

Scratch and stain resistant, outdoor porcelain pavers can handle high traffic areas.



## Easy to Clean and Sanitize

No harsh chemicals needed to clean, nonporous material is resistant to stains.

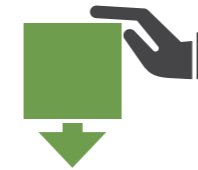

## Versatile Installation Applications

Install over grass or gravel, mortared in or simply laid on the ground.



## UV Resistant and Colorfast

Won't fade from UV exposure, retains original color over product life.

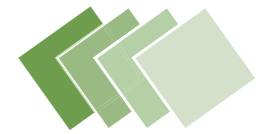

## Available in a Broad Range of Styles

Styles range from stone, concrete, or wood looks in a variety of sizes.

▼ QUARTZ | GREY 24" x 24"



## Virtually No Maintenance

Once installed, pavers require minimal upkeep and are easy to replace.



## Slip Resistant and Quick Draining

Perfect for pool decks, terraces, or even simple garden paths.



## Easy To Install

Requires minimal materials and effort to install nearly anywhere.







# +ONE

CONCRETE LOOK



## SIZES

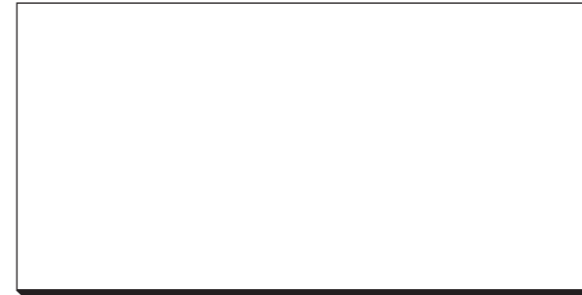

24" x 48" Rectified

Chalk	1101841
Greige	1101842
Ash	1101843



24" x 24" Rectified

Chalk	1101414
Greige	1101415
Ash	1101416

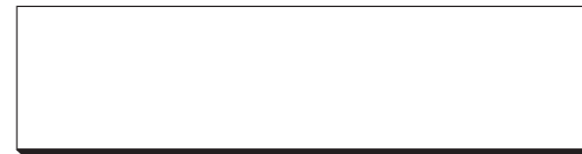

12" x 48" Rectified

Chalk	1101411
Greige	1101412
Ash	1101413

## COLORS



CHALK



GREIGE



ASH

◀ +ONE | GREIGE 12" x 48" + 24" x 24"

Colors shown may vary from actual product.  
Final selection should be made from actual product samples.



▲ +ONE | ASH 24" x 24"



▲ +ONE | CHALK 12" x 48" + 24" x 24"



# AREA 51

TERRAZZO LOOK



## SIZES

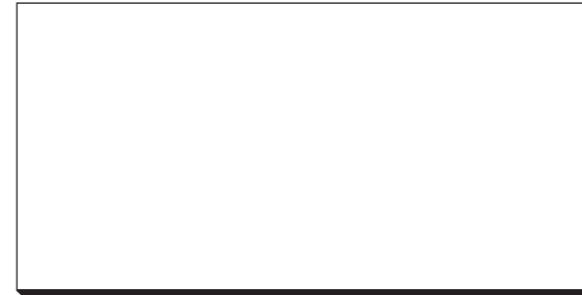

24" x 48" Rectified

White	1104834
Clay	1104835
Steel	1104836
Black	1104837

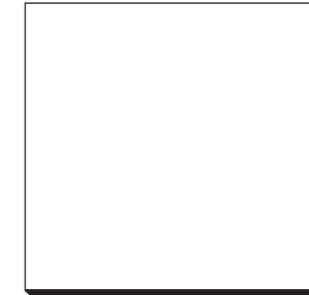

24" x 24" Rectified

White	1104847
Clay	1104848
Steel	1104849
Black	1104850

## COLORS



WHITE



CLAY



STEEL



BLACK

◀ AREA 51 | STEEL 24" x 24"

Colors shown may vary from actual product.  
Final selection should be made from actual product samples.



● AREA 51 | WHITE 24" x 24"



▲ AREA 51 | CLAY 24" x 24"



▲ AREA 51 | BLACK 24" x 24"





# EARTH

STONE LOOK



## SIZES

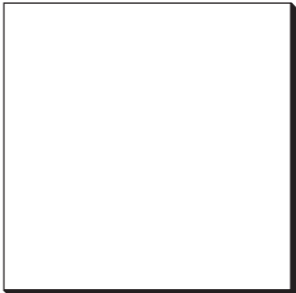

24" x 24" Rectified

- Dark Grey 1096343
- Light Grey 1096344
- Manhattan Grey 1096348
- Miami White 1096349
- Moon White 1096350
- Multicolor 1096342

## COLORS

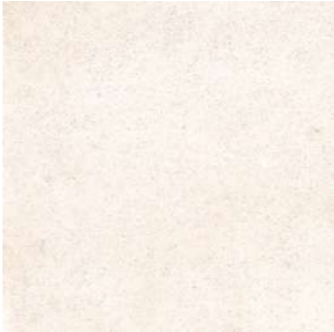

MOON WHITE



MIAMI WHITE



MANHATTAN GREY



LIGHT GREY



MULTICOLOR



DARK GREY

← EARTH | MULTICOLOR 24" x 24"

Colors shown may vary from actual product.  
Final selection should be made from actual product samples.





▲ EARTH | MOONWHITE 24" x 24" + 12" x 24" COPING



▲ EARTH | MIAMIWHITE 24" x 24"

Tile removed to show raised installation on pedestals.  
For more information, see pg. 39.



● EARTH | MANHATTAN GREY 24" x 24"



▲ EARTH | DARK GREY 24" x 24"



# FARMHOUSE LIVING

STONE LOOK

## SIZES

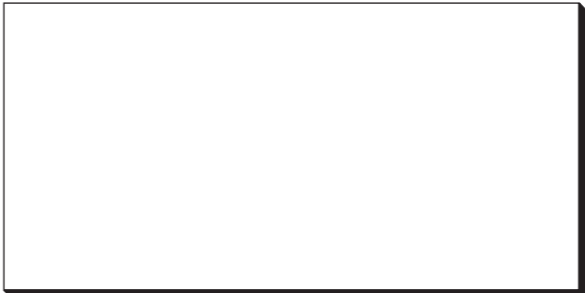

24" x 48" Rectified

- Alabaster 1104235
- Pewter 1104236
- Millstone 1104237
- Slate 1104238

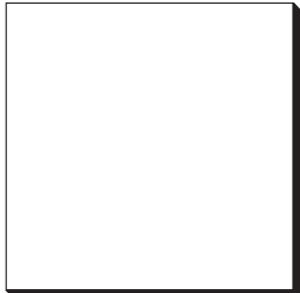

24" x 24" Rectified

- Alabaster 1104240
- Pewter 1104241
- Millstone 1104242
- Slate 1104243

## COLORS



ALABASTER



PEWTER



MILLSTONE

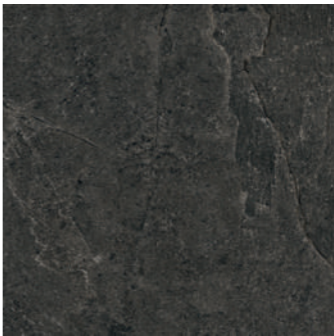

SLATE

 FARMHOUSE LIVING | ALABASTER 24" x 48"

Colors shown may vary from actual product.  
Final selection should be made from actual product samples.



▲ FARMHOUSE LIVING | PEWTER 24" x 48"



▲ FARMHOUSE LIVING | MILLSTONE 24" x 48"



# imprint



STONE LOOK

## SIZES



24" x 24" Rectified

Intaglio Cool 1105076  
Intaglio Kaolin 1105077  
Intaglio Warm 1105078

## COLORS



INTAGLIO  
COOL

INTAGLIO  
KAOLIN

INTAGLIO  
WARM

< imprint | INTAGLIO KAOLIN + INTAGLIO WARM 24" x 24"

Colors shown may vary from actual product.  
Final selection should be made from actual product samples.



▲ **imprint** | INTAGLIO COOL 24" x 24"



▲ **imprint** | INTAGLIO WARM 24" x 24"



# LITH

STONE LOOK



## SIZES

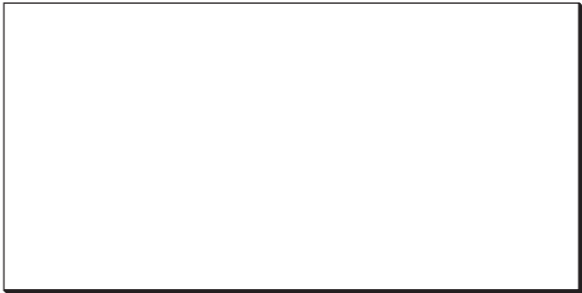

24" x 48" Rectified

- Heirloom Blue 1103563
- Antique Cream 1103562
- Legacy White 1103561

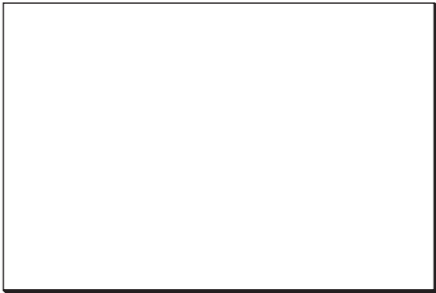

24" x 36" Rectified

- Heirloom Blue 1103585
- Antique Cream 1103584
- Legacy White 1103582

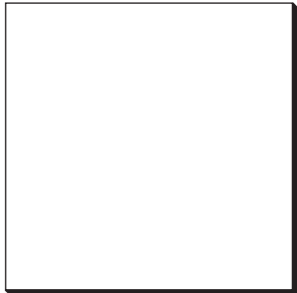

24" x 24" Rectified

- Heirloom Blue 1103575
- Antique Cream 1103574
- Legacy White 1103573

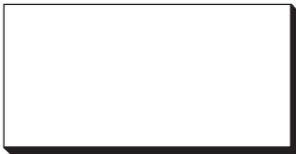

12" x 24" Rectified

- Heirloom Blue 1103578
- Antique Cream 1103577
- Legacy White 1103576

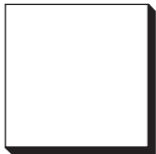

12" x 12" Rectified

- Heirloom Blue 1103581
- Antique Cream 1103580
- Legacy White 1103579

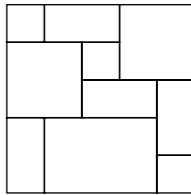

Multisize Pattern

Uses: 24" x 36", 24" x 24", 12" x 24", 12" x 12"

## COLORS

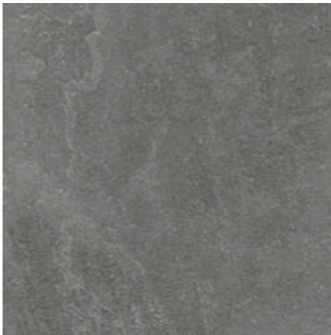

HEIRLOOM BLUE



ANTIQUÉ CREAM



LEGACY WHITE

◀ LITH | HEIRLOOM BLUE 24" x 36" + 24" x 24" + 12" x 24" + 12" x 12"

Colors shown may vary from actual product. Final selection should be made from actual product samples.



● LITH | ANTIQUE CREAM 24" x 48"



▲ LITH | LEGACY WHITE 24" x 24" + 24" x 48"



# MOOD WOOD



WOOD LOOK

## SIZES

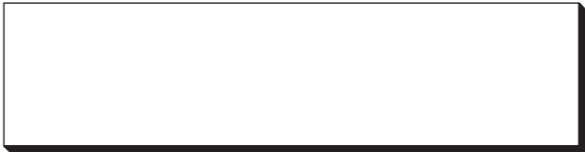

12" x 48" Rectified

White	1100818
Honey	1100819
Grey	1100822

## COLORS



WHITE



HONEY



GREY

< **MOOD WOOD** | WHITE 12" x 48"

Colors shown may vary from actual product.  
Final selection should be made from actual product samples.



▲ MOOD WOOD | HONEY 12" x 48"

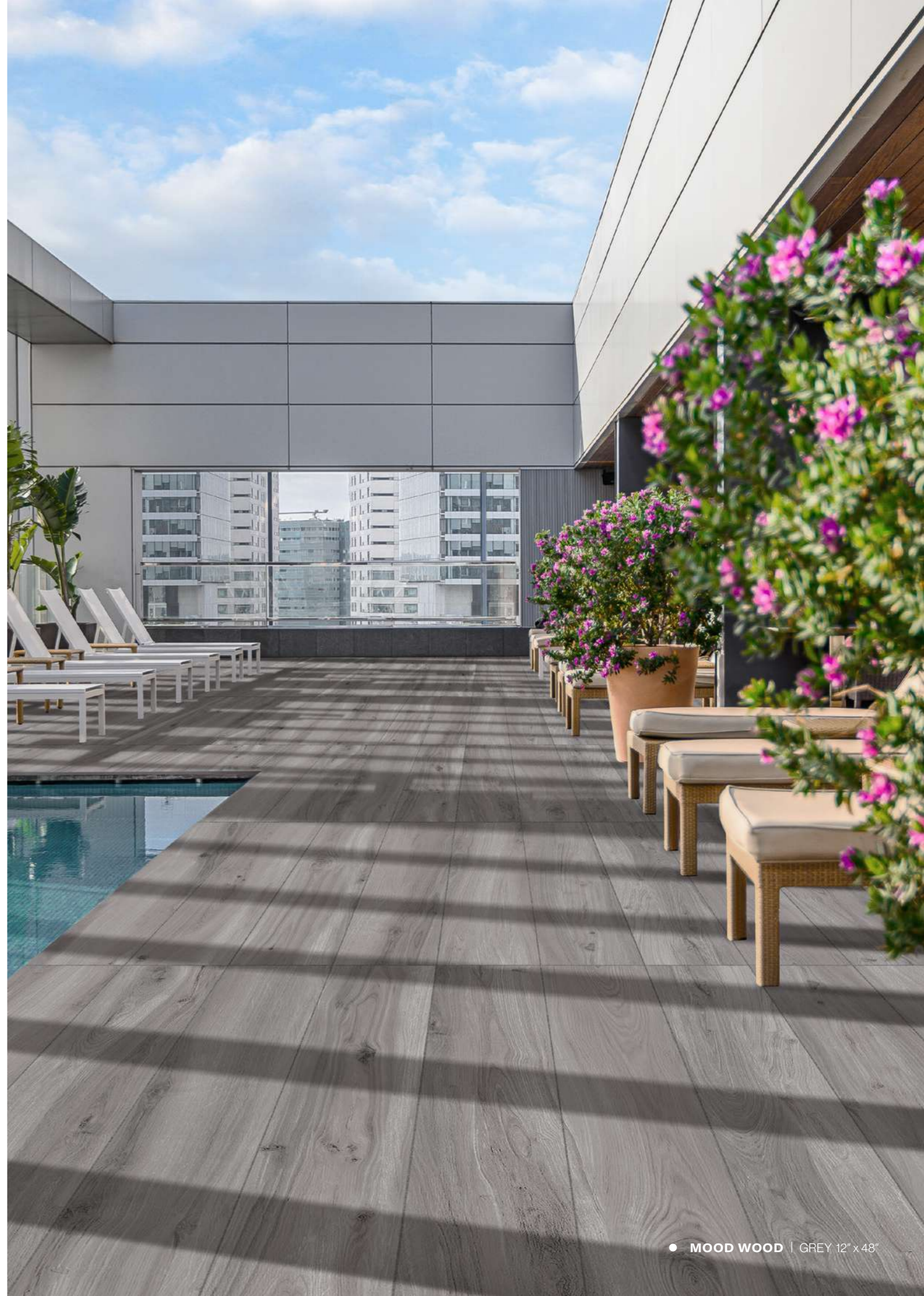

● MOOD WOOD | GREY 12" x 48"



# QUARTZ

STONE LOOK



## SIZES

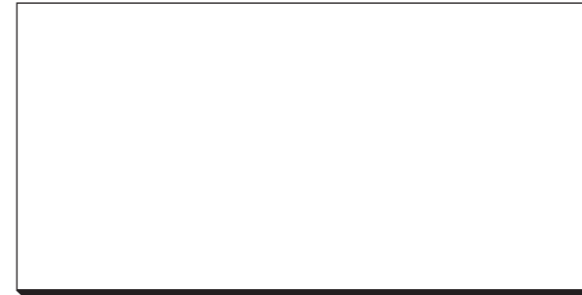

24" x 48" Rectified

Extra White 1101846  
White 1101421  
Grey 1101422

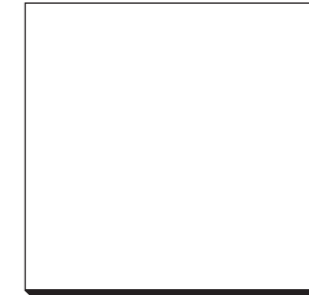

24" x 24" Rectified

Extra White 1101848  
White 1101426  
Grey 1101427

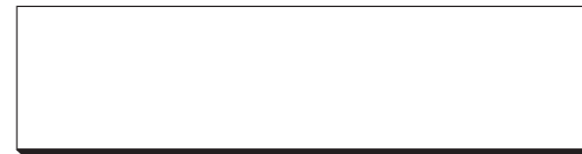

12" x 48" Rectified

Extra White 1101847  
White 1101423  
Grey 1101424

## COLORS



EXTRA WHITE



WHITE



GREY

◀ **QUARTZ** | EXTRA WHITE 12" x 48"

Colors shown may vary from actual product.  
Final selection should be made from actual product samples.



▲ QUARTZ | WHITE 12" x 48" + 24" x 24"



▲ QUARTZ | GREY 24" x 24"

## COPING

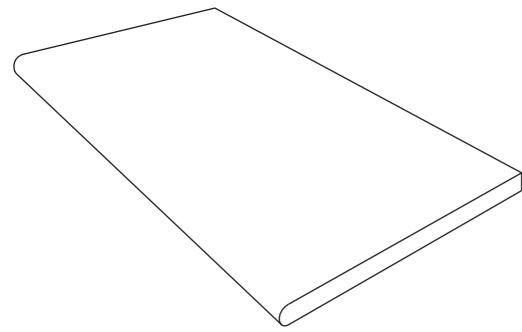

12" x 24" Coping

Edge Details:

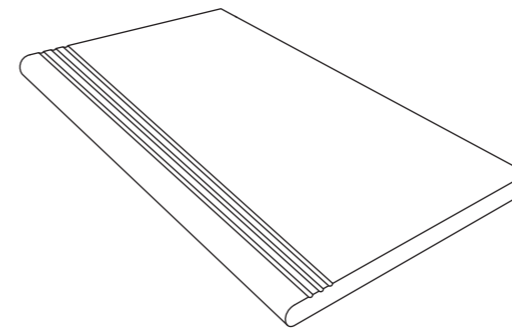
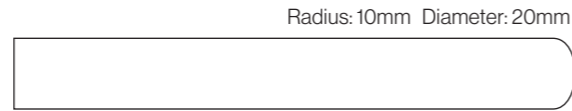

12" x 24" Coping with Stair Tread

Edge Details:

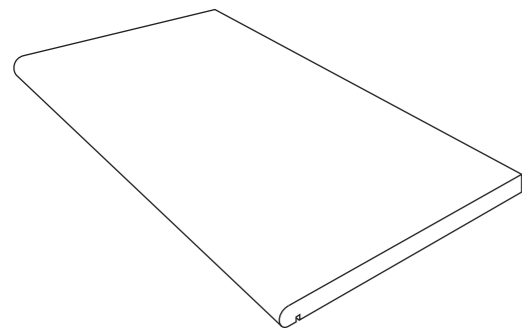

12" x 24" Drain Coping

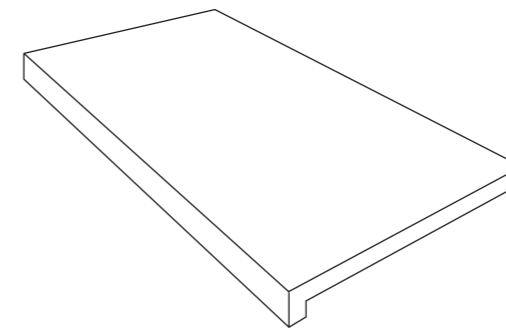
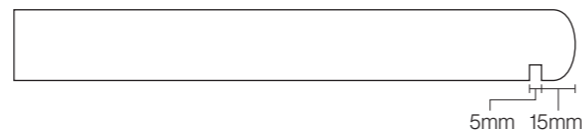

12" x 24" L-Shaped Coping

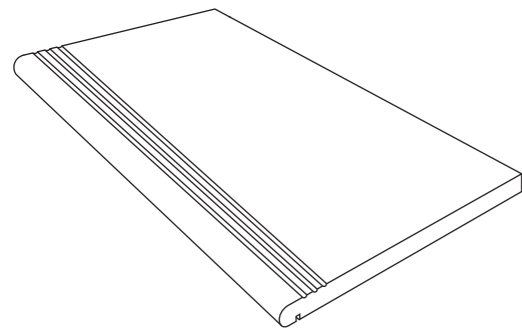
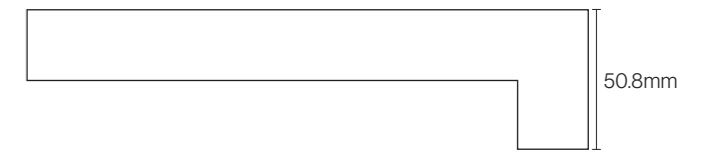

12" x 24" Drain Coping with Stair Tread

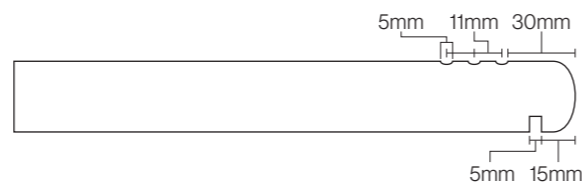









Trim pieces and field tiles may come in different shades, the slab's edge may show layers of differing hues.

Outdoor coping trim pieces available through special order only. Contact your sales representative for more information.

# TECHNICAL SPECIFICATIONS

This product meets or exceeds all standards described in ANSI A137.3.  
Este product cumple o exceed todos los estandares de ANSI A137.3.

	SPECS	TEST METHOD	INDUSTRY STANDARD	MILE <sup>®</sup> stone VALUES
	D.C.O.F.	ANSI A326.3	≥ 0.42 WET	> 0.55 WET
	FREEZE / THAW RESISTANCE	ASTM C1026	AS REPORTED	RESISTANT
	CHEMICAL RESISTANCE	ASTM C650	AS REPORTED	NOT AFFECTED
	STAIN RESISTANCE	ASTM C1378	AS REPORTED	NOT AFFECTED
	MAXIMUM STRAIGHTNESS DEVIATION % IN RELATION TO CORRESPONDING PRODUCT DIMENSIONS	ASTM C485	± 0.40% (± 1.3 mm)	± 10%
	THICKNESS VARIATION (THICKNESS RANGE WITHIN A MEASURED SAMPLE TESTED)	ASTM C499	± 1.5 mm (± 0.06 in)	± 0.5%
	LENGTH & WIDTH ADMITTED DEVIATION % OF AVERAGE SIZE OF EACH TILE FROM THE PRODUCTION DIMENSIONS	ASTM C499	± 0.5% (± 2 mm)	± 0.15%
	WATER ABSORPTION	ASTM C373	≤0.5%	≤0.5%
	BREAKING STRENGTH	ASTM C1505	≥ 2000 lbf AVERAGE (10.9 Kn)	≥ 2700 lbf INDIVIDUAL
	RESISTANCE OF DEEP ABRASION	ASTM C1243	175 mm <sup>3</sup>	< 150 mm <sup>3</sup>
	THERMAL SHOCK RESISTANCE	ASTM C484	PASS	MEETS REQUIREMENT

• Due to the inherent nature of fired porcelain tile, it is important to note that the coefficient of friction may vary within and between product runs.

## CLEANING & MAINTENANCE / ROUTINE CARE INSTRUCTIONS



Scan the QR code with your smartphone.

# PACKAGING SPECIFICATIONS

SIZES		THICKNESS (MM)	PIECES PER BOX	UOM PER BOX	WEIGHT PER BOX	BOXES PER PALLET	UOM PER PALLET	WEIGHT PER PALLET*
<b>FIELD TILES</b>								
12"x12" RECTIFIED	NOMINAL	20 mm	5	5 SF	45 LBS	45	225 SF	2,025 LBS
12"x24" RECTIFIED	NOMINAL	20 mm	4	8 SF	72 LBS	40	320 SF	2,880 LBS
12"x48" RECTIFIED	NOMINAL	20 mm	4	16 SF	147 LBS	16	256 SF	2,352 LBS
24"x24" RECTIFIED	NOMINAL	20 mm	2	8 SF	72 LBS	36	288 SF	2,592 LBS
24"x36" RECTIFIED	NOMINAL	20 mm	2	12 SF	108 LBS	16	192 SF	1,728 LBS
24"x48" RECTIFIED	NOMINAL	20 mm	2	16 SF	144 LBS	16	256 SF	2,304 LBS
QUARTZ 24"x48" RECTIFIED	NOMINAL	20 mm	2	15.5 SF	139.5 LBS	16	248 SF	2,232 LBS
<b>COPING</b>								
12"x24" COPING	NOMINAL	20 mm	4	8 SF	73.6 LBS	40	160 PCS	2,944 LBS
12"x24" STAIR TREAD COPING	NOMINAL	20 mm	4	8 SF	73.6 LBS	40	160 PCS	2,944 LBS
12"x24" DRAIN COPING	NOMINAL	20 mm	4	8 SF	73.6 LBS	40	160 PCS	2,944 LBS
12"x24" DRAIN COPING WITH STAIR TREAD	NOMINAL	20 mm	4	8 SF	73.6 LBS	40	160 PCS	2,944 LBS
12"x24" L-SHAPED COPING	NOMINAL	20 mm	4	8 SF	73.6 LBS	40	160 PSC	2,944 LBS

\*WEIGHT PER PALLET DOES NOT INCLUDE PALLET WEIGHT ITSELF. All other sizes will be packaged as ordered. Please contact MILE<sup>®</sup>stone Customer Service at 1-877-356-7461 for packaging information. Minimum grout size recommended = 5 mm (or approx. 3/16") If staggered tile placement, we recommend using a 30% offset. If specified brick pattern with 1/2 pattern mandatory, a bigger grout is recommended to hide imperfections of installation (minimum 1/4").



# INSTALLATION METHODS

## DRY LAY ON GRASS OR SAND



DIY Video

**MATERIALS:**

- Outdoor 2cm Porcelain Pavers
- Paving Sand (optional)

Direct lay installations are the easiest, fastest, and most DIY-friendly way to lay your porcelain pavers. Perfect for garden pathways or a makeshift patio, consider digging out 2" of soil and pouring road base into the hole before laying the pavers to ensure a more stable and quick-draining walkway.

## ADHESIVE INSTALLATION



DIY Video

**MATERIALS:**

- Outdoor 2cm Porcelain Pavers
- Concrete Base
- Cement Based Adhesive
- Outdoor Grout

Have an old stained and worn down concrete slab patio you're looking to refresh? Look no further, as our porcelain pavers can be installed over a concrete base, revitalizing your existing outdoor foundations.

## DRY LAY ON GRAVEL



DIY Video

**MATERIALS:**

- Outdoor 2cm Porcelain Pavers
- Road-base Gravel

Perfect for patios and other outdoor large seating areas, installing over gravel allows for a more permanent and solid foundation for your pavers, while maintaining the ease and simplicity of DIY installation.

## DRY LAY ON RAISED PEDESTALS







DIY Video

**MATERIALS:**

- Outdoor 2cm Porcelain Pavers
- Level Concrete Base
- Support Pedestals

Most suitable for commercial applications, installing on raised pedestals allows for excellent drainage. Also hides unsightly wiring, piping, or duct work, while keeping it all easily accessible.

# GREEN MEMBERSHIPS & ACCREDITATIONS

	DESCRIPTION
	Declare labels disclose all intentionally added ingredients and residuals present in the final product. Being Red List Free means the worst materials, chemicals, and elements for human and environmental health are not present within our products.
	The Health Product Declaration Collaborative transparency declaration for all of Florim USA's naturally occurring materials.
	Certification of plant and product specific Environmental Product Declaration (EPD) which tracks environmental impacts from the production of porcelain tile.
	Tile Council of North America and the American National Standards Institute's standard for sustainability and environmental impact.
	Underwriter's Laboratories certification of low emitting materials. Florim USA is Green Guard Gold certified.
	Defines post-consumer content of as much as 3% recycled material which reduces landfill impact. Certified by Bureau Veritas.
	Defines pre-consumer content of as much as 45% recycled material which reduces our carbon footprint. Certified by Bureau Veritas.
	Florim USA's sustainability and social practices support the mission of The International Living Future Institute which strives to create a socially just, culturally rich, and ecologically restorative community.
	USGBC is committed to suit a more sustainable life. Florim USA supports this mission by manufacturing products which aid architects in achieving USGBC certification.
	Florim USA sources >95% raw material within a 500 mile radius, which results in a smaller carbon footprint.
	Florim USA actively participates in the Tile Council of North America which allows us to be on the forefront of advances in the tile industry and its standards.
	The Tennessee Recycling Coalition is dedicated to promoting recycling and sustainable material management practices, and awarded Florim USA the Tennessee Recycler of the Year award for 2020.
	ISO 9001 & ISO 14001 are globally recognized standards. ISO 9001 certifies that Florim USA products and practices continually meet and exceed customer and regulatory requirements. ISO 14001 certifies that Florim USA complies with environmental regulations and that its manufacturing practices are environmentally conscious.
	Florim USA updated its corporate charter in 2022 to become a Benefit Corporation. Our company is committed to maintaining this designation through initiatives focused on sustainability, social responsibility, ethical business practices and transparent, annual reporting on our social and environmental performance.

## Progress that invests in the entire society

As an active member of the U.S. Green Building Council, MILE<sup>®</sup>stone spreads awareness to the community and encourages the use of building solutions through environmentally friendly practices. Our products positively contribute to the requirements for obtaining the LEED (Leadership in Energy and Environmental Design) and WELL (IWBI) certifications.

## A commitment to environmental sustainability and responsibility

We are committed to conscious development that minimizes the negative impact of manufacturing production on the environment. Our general approach to sustainability intersects with our business strategy to embrace three areas of responsibility: economic, social, and environmental. Some ways we prove this are:

- Products containing as much as 45% recycled content.
- Post-consumer recycled content levels as much as 3%.
- Zero industrial wastewater discharge.
- A 99% internal process recycling rate.
- Local sourcing of >95% raw materials (within 500-mile radius of factory) resulting in low transportation related carbon emissions.

MILE<sup>®</sup>stone is taking these and other steps, as well as actively investing to reduce carbon emissions to ensure that we reach full carbon neutrality.



MADE IN THE USA



300 International Blvd. Clarksville, TN 37040 | [www.milestonetiles.com](http://www.milestonetiles.com) | 1-877-356-7461

